

XS RANGE PERFORMANCE & TECHNICAL INFORMATION

Wide range of multipurpose wall, window, and roof fans with a duty range of up to 0.55m³/s and optional integrated controls.



KEY BENEFITS:

- ▶ **QUIET OPERATION** – ULTRA QUIET FAN WITH WAX THERMOS ACTUATOR, TOGETHER WITH MARKET LEADING MOTORS AND IMPELLER TECHNOLOGY.
- ▶ **HIGH PERFORMANCE** – DELIVERS INDUSTRY LEADING PERFORMANCE, COUPLED WITH LOW NOISE LEVELS.
- ▶ **FLEXIBLE SOLUTIONS** – REVERSIBLE FOR EXTRACT AND SUPPLY WITH INFINITELY VARIABLE SPEED CONTROL.
- ▶ **SAVE ENERGY & MONEY** – ECONOMY SPEED SETTING THAT WILL MAXIMISE PERFORMANCE AT THE LOWEST ENERGY USE.
- ▶ **COMPLETE USER SAFETY** – ROBUST CONSTRUCTION, MANUFACTURED FROM FLAME RETARDANT ABS POLYMER IP44 RATED FOR LONG LIFE.
- ▶ **EASY REFURBISHMENT** – XS REFURB KITS ARE QUICK TO INSTALL AND CAN BE USED TO REPLACE MOST EXISTING SYSTEMS.

TYPICAL INSTALLATION

Exposed site window installation
(use with Window Fan Kit).

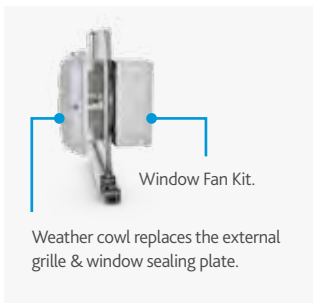

Flat roof (ducted to ceiling) installation
(use with Ceiling Fan Kit).



In-Line installation
(use with Basic Fan Unit).

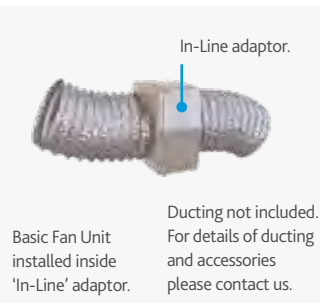

Ceiling mounted fans for ducted applications.

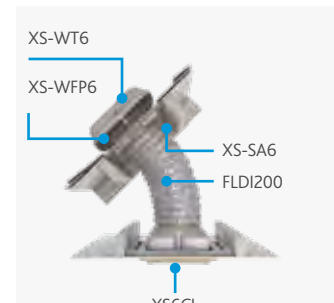

Exposed site wall installation
(use with Wall Fan Kit).

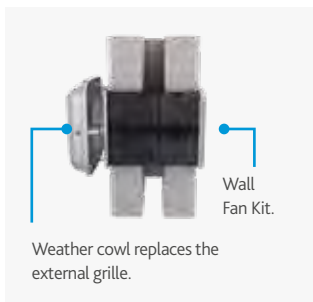

Pitched roof (ducted to ceiling) installation
(use with Pitched Roof Fan Kit).

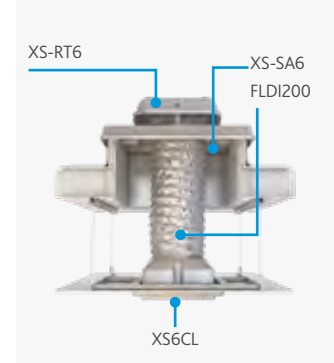
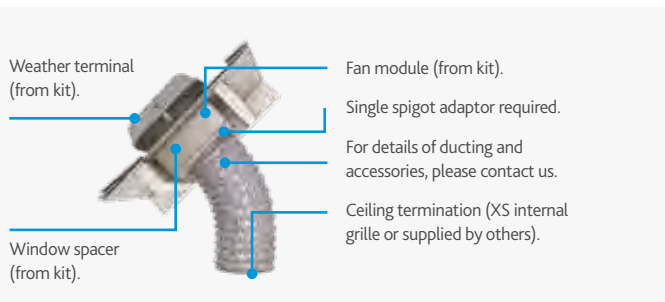

XS RANGE CONSULTANT SPECIFICATION



FAN DESCRIPTION

The extract fan/s shall be located in the positions indicated on the drawings and in accordance with the relevant fan schedule.

The fan shall be of the XS type and shall be supplied complete with integrated low loss radial backdraught shutter, silent operation via a thermo actuator, room side grille, connection kit and external louvre/ roof cowl to suit the particular application.

The high efficiency, low noise axial flow impeller shall be directly driven by an external rotor motor featuring enclosure protection to IP 44, class B winding insulation and maintenance free ball bearings.

All models shall be suitable for air over motor temperatures of up to 60°C and 95% R.H (non-condensing). The motor and impeller shall be dynamically balanced as an assembly.

Fan casing, impeller and shutter shall be manufactured from UV stabilised ABS polymer. All models shall include an economy/high efficiency setting facility and are dove grey in colour.

The fan shall be provided complete with integrated or remote controls as detailed in the schedule and as described below.

Where indicated the fans shall be interlinked and controlled from 1No. controller (up to 5 fans sizes 6 & 9, up to 3 fans size 12).

Fans shall be reversible via reversing switch on XS-MFC fan controller.

Fan to be of the XS type as manufactured by Nuaire.

FAN CONTROL OPTION

The fan shall be provided with either integrated sensor to activate the fan or one of the remote options:

INTEGRATED CONTROL OPTIONS:

- PIR (passive infra-red) movement detector (includes run-on timer), 2-40 mins RT.
- Humidity sensor (includes run-on timer), 30-90% RH - 2-40 mins RT.
- Air quality sensor (includes run-on timer), 2-40 mins RT.
- Run-on timer, 2-40 mins RT.
- Temperature sensor (includes run-on timer), 5-35°C (fixed 2mm overrun).

REMOTE CONTROL OPTIONS:

- PIR (passive infra-red) movement detector (includes run-on timer), 2-40 mins RT.
 - Humidity sensor (includes run-on timer), 30-90% RH - 2-40 mins RT.
 - Air quality sensor (includes run-on timer), 2-40 mins RT.
 - Anti-tamper security strap.
 - XS-MFC controller incorporating economy switch, reversing
- 1No. XS-MFC controller may be used to control up to 5 fans.

Fan, integrated controls or associated sensors/controllers shall be as manufactured by Nuaire.

The manufacturer's recommendations should be observed at all times.

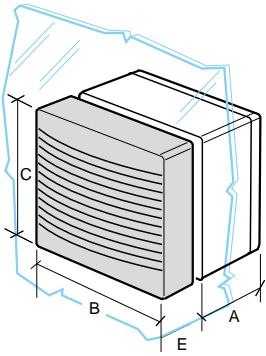

XSGL WINDOW MOUNTED FAN

DIMENSIONS (MM) AND WEIGHT (KG)

MODEL	A	B	C	D	E	WEIGHT
XS6GL	161	269	269		31	4.65
XS9GL	158	342	342		35	6.3
XS12GL	172	420	420		46	8.7

CODING XS6GL

XS 6 GL
| | |
1 2 3

SAMPLE CODING

1. XS range
2. Size indication
3. GL = window model

XSGL PERFORMANCE REPRESENTS COMPLETE FAN KIT

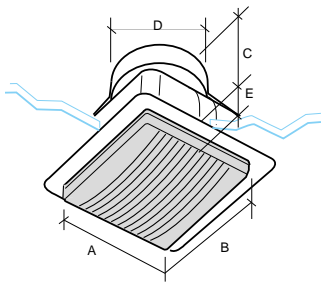
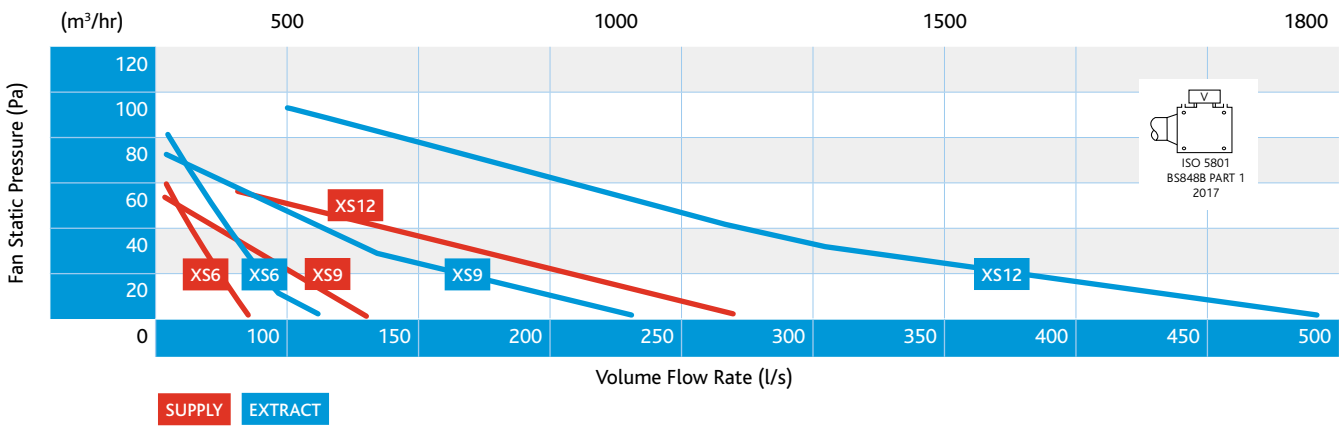

XSCL CEILING MOUNTED FAN

DIMENSIONS (MM) AND WEIGHT (KG)

MODEL	A	B	C	D	E	WEIGHT
XS6CL	269	272	200	200	30	3.95
XS9CL	342	342	200	250	30	5.5
XS12CL	420	420	200	350	30	8.7

CODING XS6CL

XS 6 CL
| | |
1 2 3

SAMPLE CODING

1. XS range
2. Size indication
3. CL = ceiling model

XSCL PERFORMANCE REPRESENTS COMPLETE FAN KIT

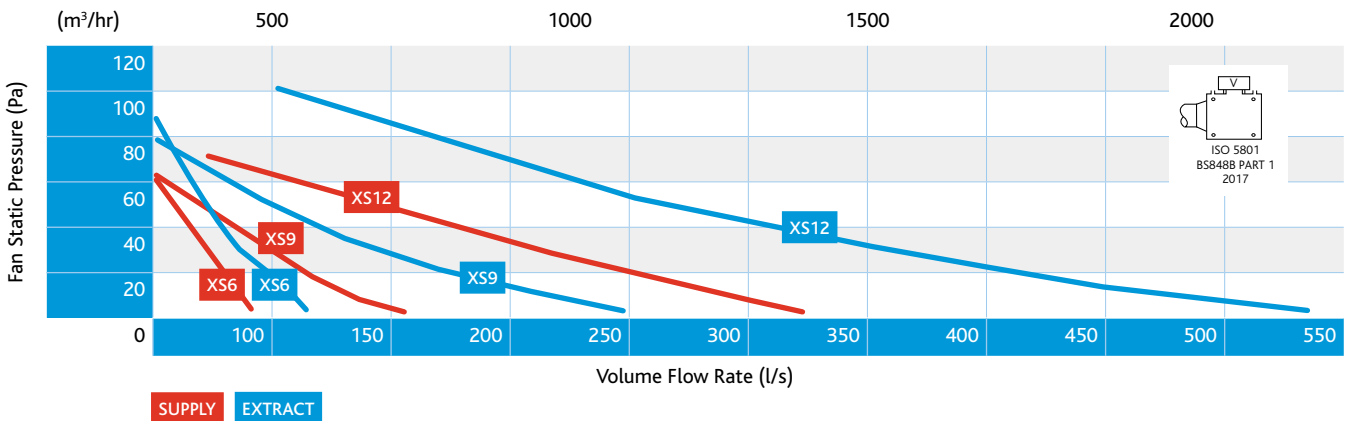

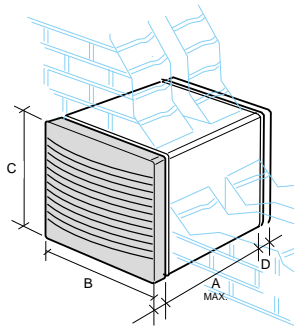

XS WA WALL MOUNTED FAN

DIMENSIONS (MM) AND WEIGHT (KG)

MODEL	A	B	C	D	WEIGHT
XS6WA	370	269	269	31	4.7
XS9WA	370	342	342	35	6.45
XS12WA	370	420	420	46	9.4

CODING XS6WA

XS 6 WA
| | |
1 2 3

SAMPLE CODING

1. XS range
2. Size indication
3. WA = wall model

XS WA PERFORMANCE REPRESENTS COMPLETE FAN KIT

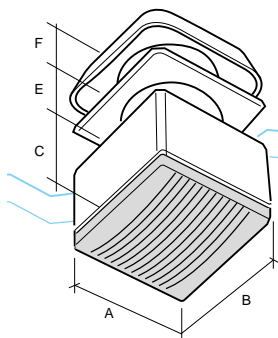
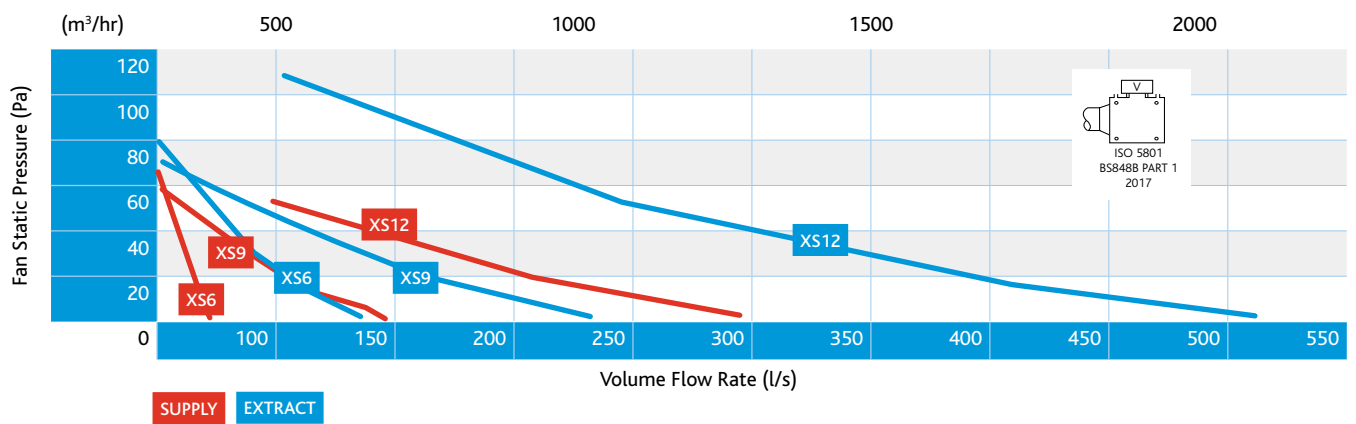

XS PR/FR ROOF MOUNTED FAN

DIMENSIONS (MM) AND WEIGHT (KG)

MODEL	A	B	C	D	E	F	WEIGHT
XS6PR	369	269	161		150	170	6.3
XS9PR	342	342	158		150	180	8.9
XS12PR	420	420	172		150	185	11.8
XS6FR	269	269	161		150	170	8.31
XS9FR	342	342	158		150	180	10.26
XS12FR	420	420	172		150	145	11

CODING XS6PR

XS 6 PR
| | |
1 2 3

SAMPLE CODING

1. XS range
2. Size indication
3. PR = pitched-roof model
FR = flat-roof model

XS PR/FR PERFORMANCE REPRESENTS COMPLETE FAN KIT

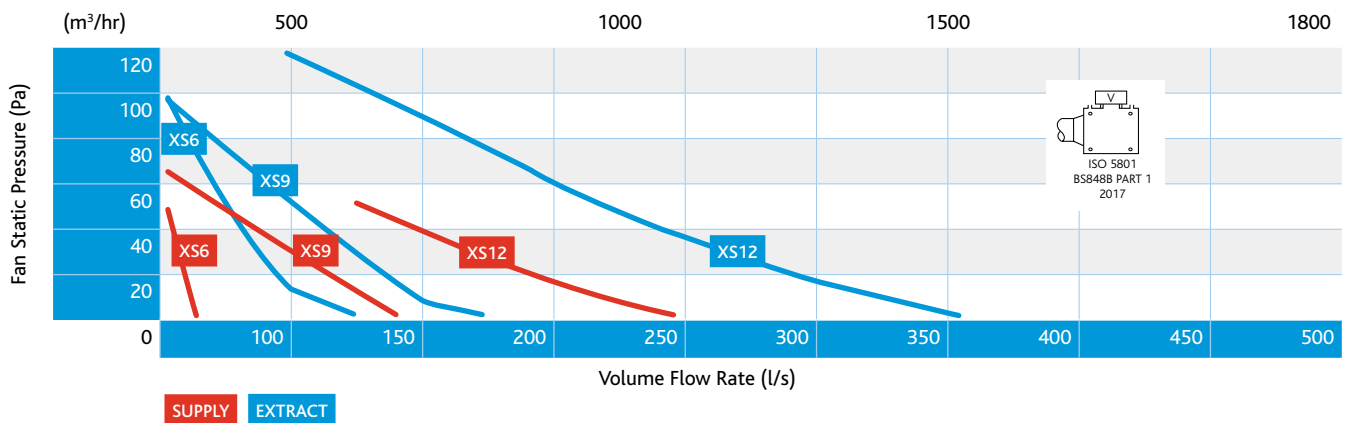

SUPPLY

CODE	PHASE	RPM SPEED	MOTOR CURRENTS		SOUND POWER LEVELS RE 1 PWATT (Hz) INDUCT INLET								dB(A) @3M
			FLC (A)	SC (A)	63	125	250	500	1K	2K	4K	8K	
XS6CL	1	2000	0.19	0.6	53	67	58	57	58	59	50	42	42
XS6FR	1	2000	0.19	0.6	50	77	63	63	53	50	43	35	44
XS6GL	1	2000	0.19	0.6	55	68	59	56	57	57	49	41	41
XS6PR	1	2000	0.19	0.6	50	77	63	63	53	50	43	35	44
XS6WA	1	2000	0.19	0.6	54	68	60	57	58	57	49	41	42
XS9CL	1	1400	0.26	0.8	44	56	57	56	58	57	53	44	42
XS9FR	1	1400	0.26	0.8	52	59	57	57	59	58	54	45	43
XS9GL	1	1400	0.26	0.8	64	71	61	56	56	55	48	38	41
XS9PR	1	1400	0.26	0.8	52	59	57	57	59	58	54	45	43
XS9WA	1	1400	0.26	0.8	57	67	61	53	54	52	47	38	39
XS12CL	1	1370	0.48	1.32	62	66	63	65	66	62	56	49	48
XS12FR	1	1370	0.44	1.32	65	70	65	65	61	54	49	42	45
XS12GL	1	1370	0.48	1.32	65	70	65	64	62	59	53	46	46
XS12PR	1	1370	0.44	1.32	65	70	65	65	61	54	49	42	45
XS12WA	1	1370	0.48	1.32	63	70	63	61	62	49	53	45	45

EXTRACT

CODE	PHASE	RPM SPEED	MOTOR CURRENTS		SOUND POWER LEVELS RE 1 PWATT (Hz) INDUCT INLET								dB(A) @3M
			FLC	SC (DOL)	63	125	250	500	1K	2K	4K	8K	
XS6CL	1	2000	0.19	0.6	46	52	55	51	58	58	53	42	42
XS6FR	1	2000	0.19	0.6	47	52	49	52	57	58	54	44	41
XS6GL	1	2000	0.19	0.6	46	51	52	52	57	57	53	42	41
XS6PR	1	2000	0.19	0.6	47	52	49	52	57	58	54	44	41
XS6WA	1	2000	0.19	0.6	44	51	53	51	57	58	53	42	41
XS9CL	1	1400	0.26	0.8	61	66	58	52	53	53	47	37	38
XS9FR	1	1400	0.26	0.8	60	68	63	58	55	50	44	36	40
XS9GL	1	1400	0.26	0.8	47	64	55	52	57	56	53	44	41
XS9PR	1	1400	0.26	0.8	60	68	63	58	55	50	44	36	40
XS9WA	1	1400	0.26	0.8	48	67	61	55	62	59	54	45	44
XS12CL	1	1370	0.48	1.32	67	70	64	64	63	59	53	46	46
XS12FR	1	1370	0.44	1.32	64	67	66	65	65	62	57	50	48
XS12GL	1	1370	0.48	1.32	58	63	61	62	65	61	56	49	47
XS12PR	1	1370	0.44	1.32	64	67	66	65	65	62	57	50	48
XS12WA	1	1370	0.48	1.32	57	63	65	62	64	61	55	48	47

XS FAN ANCILLARIES



UNIT SIZE	SPEED CONTROL	INTEGRAL SENSORS					REMOTE SENSORS			REFURB KIT
		PIR	HUMIDISTAT	AIR QUALITY	TIMER	TEMP	PIR	HUMIDISTAT	AIR QUALITY	
XS6	XS-MFC	XS-PIR6	XS-H6	XS-AQ6	XS-TA6	XS-TH6	XS-PIRR	XS-HR	XS-AQR	XS6RE
XS9	XS-MFC	XS-PIR9	XS-H9	XS-AQ9	XS-TA9	XS-TH9	XS-PIRR	XS-HR	XS-AQR	XS9RE
XS12	XS-MFC	XS-PIR12	XS-H12	XS-AQ12	XS-TA12	XS-TH12	XS-PIRR	XS-HR	XS-AQR	XS12RE

Note: *On fan sizes 6/9 up to 5 fans can be controlled. On fan size 12 up to 3 can be controlled.

**Do not mix different fan sizes on the same controller.



BASIC FAN UNIT	WINDOW SPACER	SINGLE SPIGOT ADAPTOR	WEATHER TERMINAL	ROOF TERMINAL	INLINE ADAPTOR	WALL FIXING PLATE	PICTURE FRAMING ADAPTOR	EXTENDED FIXING RODS
Motor, impeller and shutter assembly.	Used for exposed site installation. One spacer. Use with weather terminals.	For ducted systems. Replaces internal grille.	For exposed window installations. No fan included.	No fan included.	For use with in-line duct applications.	Used for timber and thin walls, pitched roof and above ceiling. One fixing plate. Used with window kits, spacers and/or weather terminals.	For panel, ceiling or retro installations where uneven walls need to be fixed.	For extending wall kit up to 360mm.
XS6	XS-WS6	XS-SA6	XS-WT6	XS-RT6	XS-IDK6	XS-WFP6	XS-PFA6	XS-EFR
XS9	XS-WS9	XS-SA9	XS-WT9	XS-RT9	XS-IDK9	XS-WFP9	XS-PFA9	XS-EFR
XS12	XS-WS12	XS-SA12	XS-WT12	XS-RT12	XS-IDK12	XS-WFP12	XS-PFA12	XS-EFR