

ductmaster

DUCTING & ANCILLARIES

housebuilder
product
awards
2014
winner



FOR EVERY
DUCTING
SOLUTION

system approval
LABC



ductmaster

DUCTING & ANCILLARIES

Ductmaster is a fully comprehensive range of installation ancillaries for all ducted applications, to ensure you achieve the most cost effective solution.



DUCTMASTER THERMAL

Ductmaster Thermal:

Nuaire's award winning Ductmaster Thermal range is a quick and effective solution for ducting in unheated spaces. Unlike other thermal ducting systems that fit around the PVC pipe, Nuaire's Ductmaster is an all in one complete insulated ducting system, providing a cost-effective and quick installation.



DUCTMASTER PVC

Ductmaster PVC:

A comprehensive range of PVC ducting and ancillaries for the domestic market, Ductmaster PVC is available as a circular duct, a slim duct which is ideal for apartments or ceiling voids, or a flat duct for where space is at a premium.



DUCTMASTER RADIAL

Ductmaster Radial:

Nuaire Ductmaster Radial (NRD75) is a range of semi-rigid ducting and ancillaries, intended for installation in domestic properties. Unlike other types of ducting systems, Nuaire's radial ducting design negates the need for multiple lengths of duct, bends and ancillaries, minimising duct leakage and reducing installation time. Ductmaster Radial works perfectly with the Ductmaster Thermal ducting.



Ductmaster Thermal

Ductmaster Thermal is an award winning, all-in-one thermal ducting solution that fully complies with building regulations.

The lightweight material means that installation becomes a one-man job, while the unique clip system forms an airtight seal, with no need for sealant or tape. Installation is quick and easy, significantly reducing both costs and time spent on site.

The only complete solution on the market

- Fully compliant with Building Regulations
- Improved thermal efficiency
- Unique clamping mechanism – no requirement for sealant and tape
- Lightweight material - one person install
- Simple quick-fit components
- Significantly reduces time on site
- Environmentally friendly through eco-efficiency
- Cost-effective solution
- Independently tested for thermal conductivity by BASF – Germany
- LABC Approved
- Patent Pending
- Independently tested for air-tightness by BRE

Thermal Ducting Building Regulations

Ductmaster's range of thermal duct is specifically designed to comply with 2010 Building Regulations to significantly improve thermal conductivity and thermal resistance of ventilation ducting used in domestic properties.

The requirement

Ducting should be insulated where it passes through unheated areas and voids (e.g. loft spaces) with equivalent of at least 25mm of a material having a thermal conductivity of $\leq 0.04W/(m.K)$ to reduce the possibility of condensation forming. Where a duct extends above roof level the section above the roof should be insulated or a condensate trap should be fitted just below roof level.

The reason

Ducting in MVHR systems carry warm air through them. When these ducts pass through unheated spaces, such as a loft, if the ductwork does not have sufficient thermal insulation condensation can form on the ductwork and cause water damage to your property.



BUILDING REGULATIONS COMPLIANT



How Nuaire Thermal Complies

THE SIMPLE SOLUTION TO MEET BUILDING REGULATIONS

The most common method of insulation duct used through unheated spaces is bubble wrapped ductwork (figure 1), which has limited thermal resistance.

An alternative method is to wrap the ductwork in 25mm of rockwool (figure 2) which can be very labour intensive and can be prone to human error, often leaving areas of the ductwork uncovered.

Nuaire's Ductmaster Thermal (figure 3) significantly improves thermal efficiency and is the simplest, most cost effective solution to meet current building regulations.

WATCH THE
DUCTMASTER THERMAL RACE
The Race Is On!

Scan the QR code or visit the Nuaire YouTube channel:
www.youtube.com/NuaireGroup



Typical Installation Methods



Figure 1: Bubble wrap

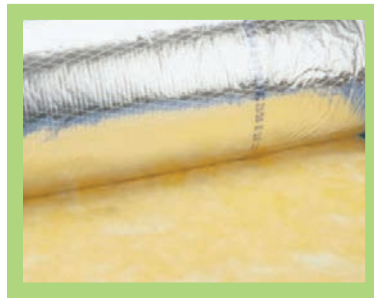
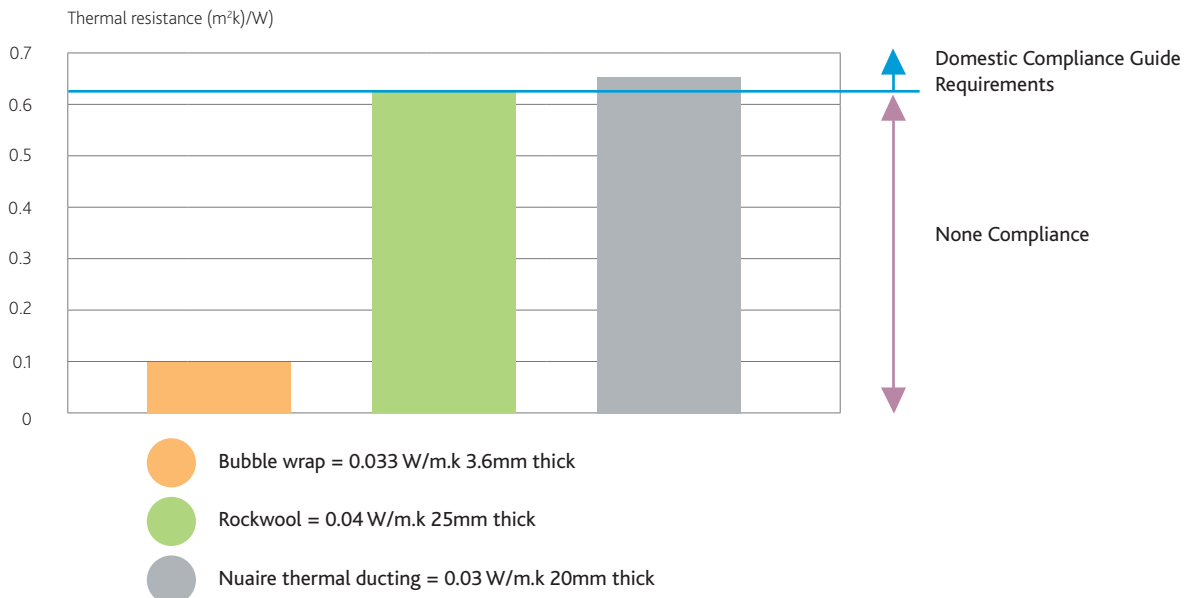

Figure 2: Rockwool



Figure 3: Nuaire thermal ducting

COMPLIANCE CHART



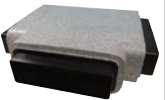

Rectangular Ducting Ancillaries - 204mm x60mm

INSULATED DUCT 1M LENGTH									
Part Number	Duct Size	Description	Box Quantity	Resistance in PA					
				@8l/s	@13l/s	@21l/s	@29l/s	@37l/s	
NTD-204-1M	204mm x 60mm	Insulated Duct 1m	6	0.2	0.4	0.8	1.4	2.2	

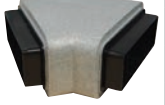

INSULATED T PIECE									
Part Number	Duct Size	Description	Box Quantity	Resistance in PA					
				@8l/s	@13l/s	@21l/s	@29l/s	@37l/s	
NTD-204-TP	204mm x 60mm	Insulated T Piece	6	0.9	2.3	5.9	11.2	18.3	

INSULATED 90° HORIZONTAL BEND									
Part Number	Duct Size	Description	Box Quantity	Resistance in PA					
				@8l/s	@13l/s	@21l/s	@29l/s	@37l/s	
NTD-204-90H	204mm x 60mm	Insulated 90° Horizontal Bend	6	0.6	1.6	4.1	7.9	12.8	

INSULATED 45° HORIZONTAL BEND									
Part Number	Duct Size	Description	Box Quantity	Resistance in PA					
				@8l/s	@13l/s	@21l/s	@29l/s	@37l/s	
NTD-204-45H	204mm x 60mm	Insulated 45° Horizontal Bend	6	0	0.3	1.2	2.6	4.5	

INSULATED 90° VERTICAL BEND									
Part Number	Duct Size	Description	Box Quantity	Resistance in PA					
				@8l/s	@13l/s	@21l/s	@29l/s	@37l/s	
NTD-204-90V	204mm x 60mm	Insulated 90° Vertical Bend	6	0.7	1.9	5.2	10.1	16.6	

INSULATED PLENUM TO 125mm DIAMETER									
Part Number	Duct Size	Description	Box Quantity	Resistance in PA					
				@8l/s	@13l/s	@21l/s	@29l/s	@37l/s	
NTD-204-PL	204mm x 60mm	Insulated Plenum	6	0.5	1.3	3.4	6.4	10.4	

DUCT CLAMPS									
Part Number	Duct Size	Description	Box Quantity	Resistance in PA					
				@8l/s	@13l/s	@21l/s	@29l/s	@37l/s	
NTD-204-CONL	204mm x 60mm	Duct clamps with fixing lugs	6	-	-	-	-	-	
NTD-204-CON	204mm x 60mm	Duct clamps without fixing lugs	6	-	-	-	-	-	

CUTTING AID									
Part Number	Duct Size	Description	Box Quantity	Resistance in PA					
				@8l/s	@13l/s	@21l/s	@29l/s	@37l/s	
NTD-204-CUTTING AID	204mm x 60mm	Cutting Aids for Ductmaster Thermal Rectangular Ducting	1	-	-	-	-	-	

125mm Circular Ducting Ancillaries

INSULATED T PIECE									
Part Number	Duct Size	Description	Box Quantity	Resistance in PA					
				@8l/s	@13l/s	@21l/s	@29l/s	@37l/s	
NTD-125-TP	125mm	Insulated T Piece	6	0.5	1	2.2	3.9	6.1	

INSULATED 90° BEND									
Part Number	Duct Size	Description	Box Quantity	Resistance in PA					
				@8l/s	@13l/s	@21l/s	@29l/s	@37l/s	
NTD-125-90H	125mm	Insulated 90° Bend	6	0.5	1.4	4	7.9	13	

INSULATED 45° HORIZONTAL BEND									
Part Number	Duct Size	Description	Box Quantity	Resistance in PA					
				@8l/s	@13l/s	@21l/s	@29l/s	@37l/s	
NTD-125-45HTP	125mm	Insulated 45° Horizontal Bend	6	0.2	0.5	1.4	2.7	4.5	

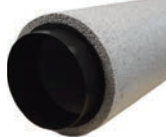
INSULATED T DUCT 1M LENGTH									
Part Number	Duct Size	Description	Box Quantity	Resistance in PA					
				@8l/s	@13l/s	@21l/s	@29l/s	@37l/s	
NTD-125-1M	125mm	Insulated DUCT 1M Length	6	0.1	0.2	0.4	0.65	0.9	

INSULATED ROUND DUCT CLAMP WITH FIXING LUGS									
Part Number	Duct Size	Description	Box Quantity	Resistance in PA					
				@8l/s	@13l/s	@21l/s	@29l/s	@37l/s	
NTD-125-CONL	125mm	Insulated Duct Clamps With Fixing Lugs	6	-	-	-	-	-	

INSULATED ROUND DUCT CLAMPS									
Part Number	Duct Size	Description	Box Quantity	Resistance in PA					
				@8l/s	@13l/s	@21l/s	@29l/s	@37l/s	
NTD-125-CON	125mm	Insulated Duct Clamps Without Fixing Lugs	6	-	-	-	-	-	

DUCT CLAMPS									
Part Number	Duct Size	Description	Box Quantity	Resistance in PA					
				@8l/s	@13l/s	@21l/s	@29l/s	@37l/s	
NTD-125-CONL	125mm	Duct clamps with fixing lugs	6	-	-	-	-	-	
NTD-125-CON	125mm	Duct clamps without fixing lugs	6	-	-	-	-	-	

CUTTING AID									
Part Number	Duct Size	Description	Box Quantity	Resistance in PA					
				@8l/s	@13l/s	@21l/s	@29l/s	@37l/s	
NTD-125-CUTTING AID	125mm x 60mm	Cutting Aids for Ductmaster Thermal Round Ducting	1	-	-	-	-	-	-



CONDENSATION TRAP									
Part Number	Duct Size	Description	Box Quantity	Resistance in PA					
				@8l/s	@13l/s	@21l/s	@29l/s	@37l/s	
NTD-125-CON-TRAP	125mm	Ductmaster Thermal Condensation Trap	1	-	-	-	-	-	-



- Use rigid duct for the majority of your installation
- Avoid using flexible ducting, if you must, remember the regulations, pull taut to 90% of its length, support the install and don't install where it can be crushed
- Minimise bends and ensure your duct routes take the path of least resistance
- Use insulated ducting for unheated spaces or heated spaces that are carrying cold air
- Install Nuaire's CONTRAP and install the ductwork correctly to prevent backflow of moisture going to the fan unit
- Follow the design provided by Nuaire.

General Arrangement

TYPICAL MVHR DUCTED ARRANGEMENT FOR A CEILING VOID MOUNTED UNIT USING RECTANGULAR INSULATED AND UNINSULATED 204 X 60MM DUCTING

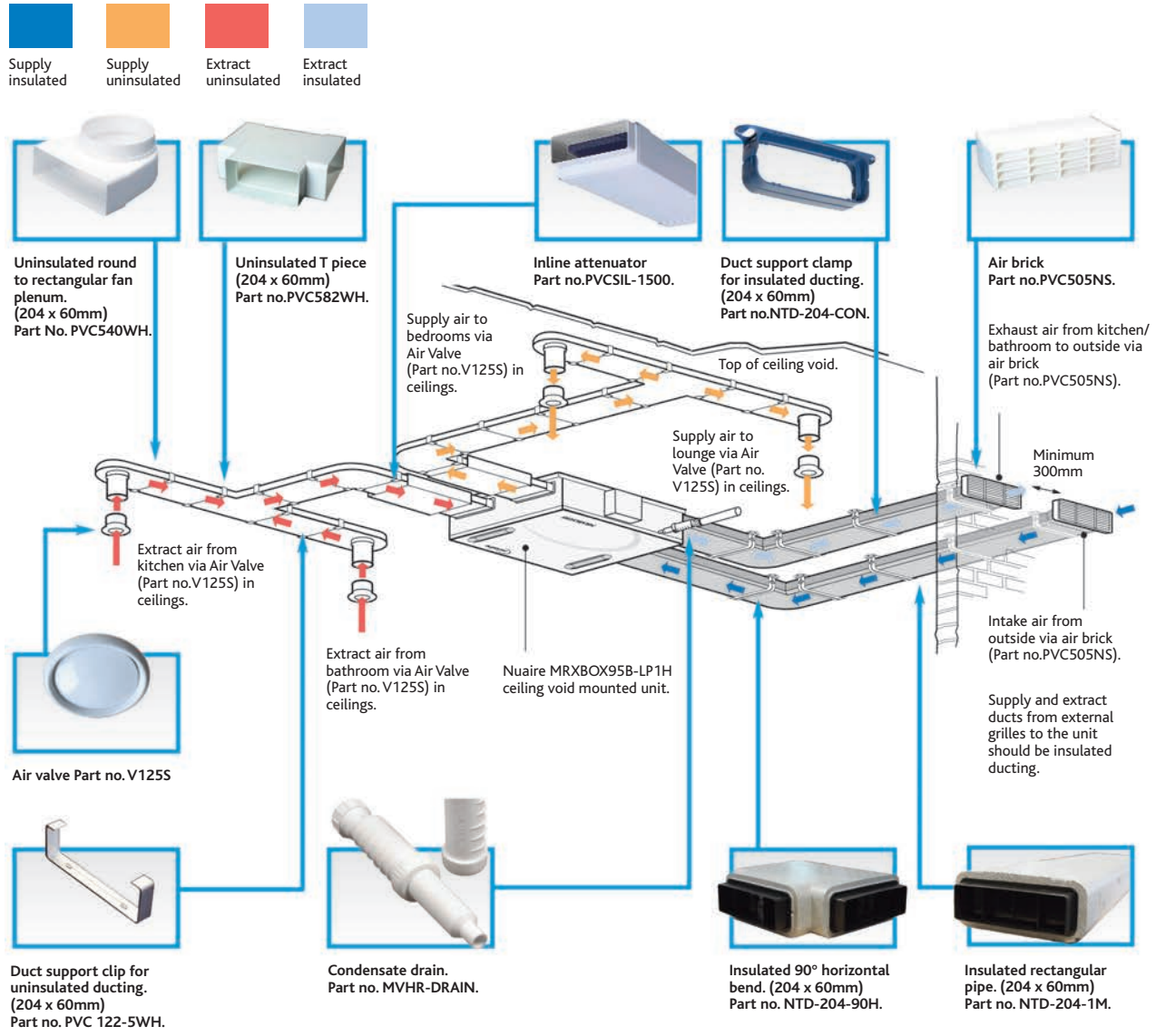

USING DUCT CLAMP NTD-204-CON WITH RECTANGULAR INSULATED DUCT PIPE.

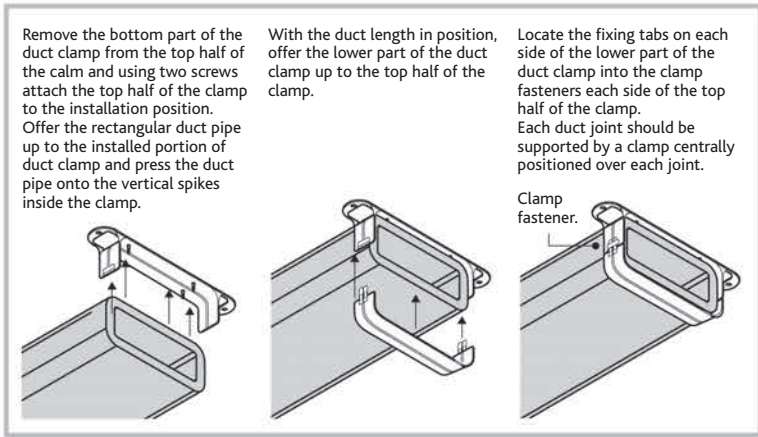

OTHER INSULATED DUCTING ANCILLARIES

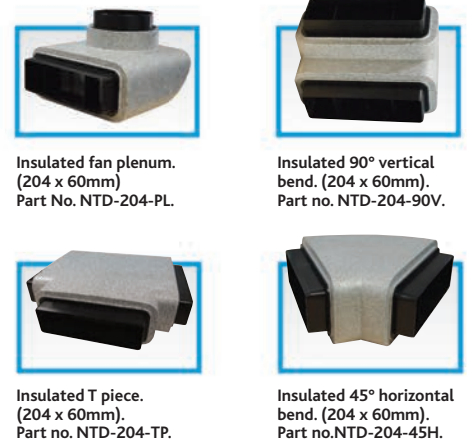

General Arrangement

TYPICAL MVHR DUCTED ARRANGEMENT FOR A WALL MOUNTED UNIT USING ROUND INSULATED AND UNINSULATED 125MM DIAMETER DUCTING

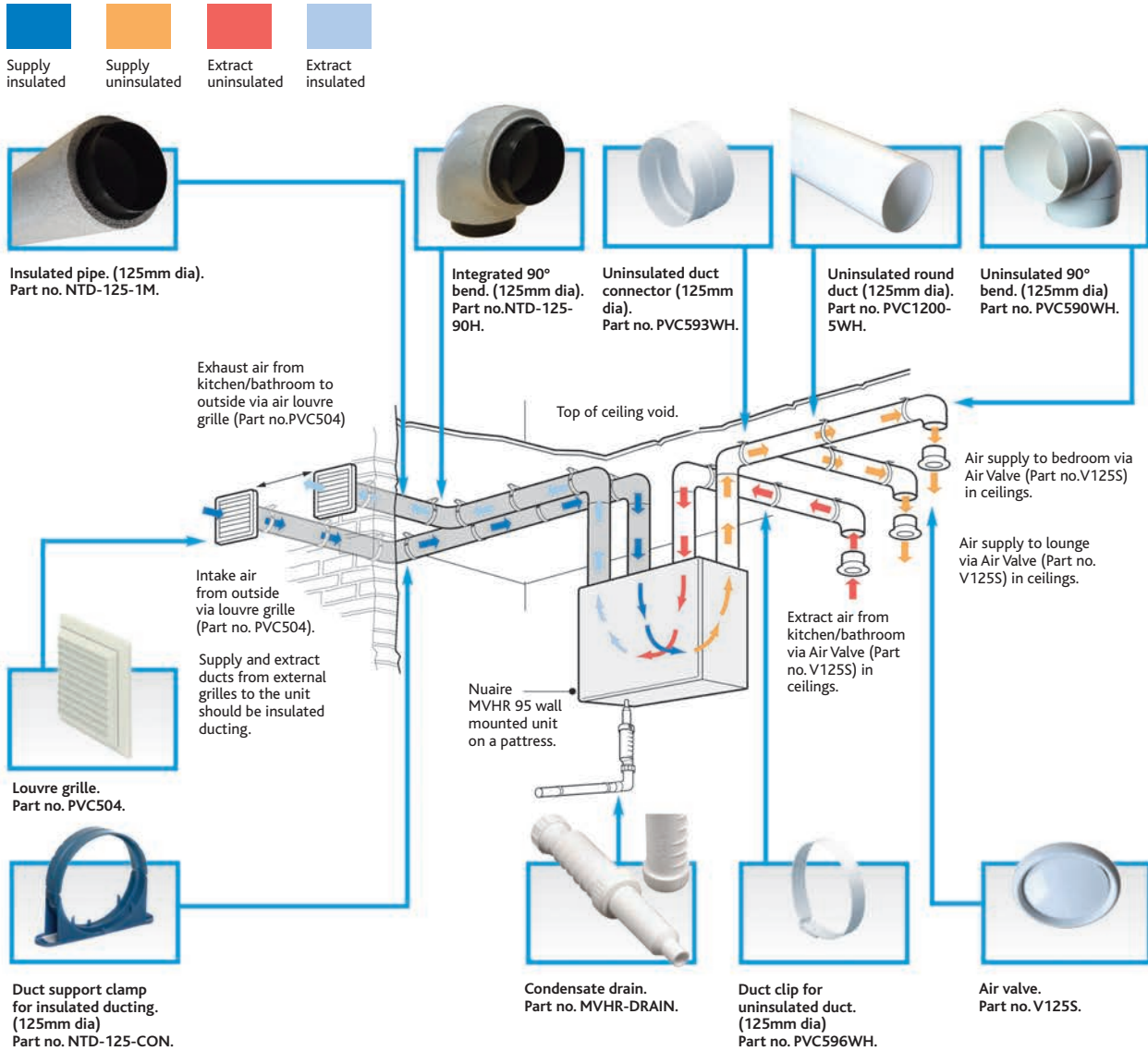

USING DUCT CLAMP NTD-204-CON WITH RECTANGULAR INSULATED DUCT PIPE.

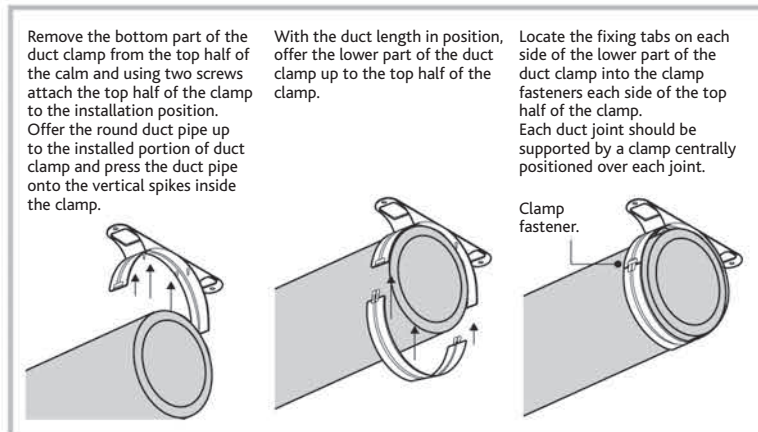

OTHER INSULATED DUCTING ANCILLARIES



Product Specification

MANUFACTURER

Nuaire Ltd.

PRODUCT BRAND NAME

Ductmaster

MATERIAL

Injection moulded 20mm in thickness; carbon impregnated Expanded Polystyrene (EPS) Density: 25 Kg/m³ Colour: Silver/Grey

THERMAL CONDUCTIVITY

Thermal conductivity tested to BASF EN13163

FIRE RESISTANCE

Flame retardant to Class EN13501-1

ENVIROMENTAL

Environmentally friendly through high eco-efficiency

PRODUCTS

Nuaire Ductmaster thermal insulated duct shall be available in two different sizes, based on the internal dimension: 125mm Diameter or 204 x 60mm rectangular. Unlike other thermal ducting systems Nuaire's unique ducting design negates the need for solid plastic inner ducting to achieve the required thermal properties and leakage rates stipulated by building regulations.

CLAMPING MECHANISM SPECIFICATION

Material: Acrylonitrile Butadiene Styrene (ABS)

Colour: Blue - RAL 5015

COMPONENT DESCRIPTIONS

Nuaire's fast clamp system shall achieve a level of leakage substantially lower than the maximum allowed for a class A duct as defined in DW/143 (Ductwork leakage testing). Fast clamps also negate the need to use any sealants or tapes to join the duct pieces resulting in a cleaner, faster and easier installation on site.

NTD-125-CONL: 125mm DIAMETER CLAMP WITH FIXING LUGS

NTD-125-CON: 125mm DIAMETER CLAMP WITH OUT FIXING LUGS

NTD-204-CONL: 204X60 CLAMP WITH FIXING LUGS

NTD-204-CON: 204X60 CLAMP WITH OUT FIXING LUGS

Ductmaster PVC

Nuaire provides a comprehensive range of ancillaries for all ducted applications to ensure the most cost effective solution can be achieved.

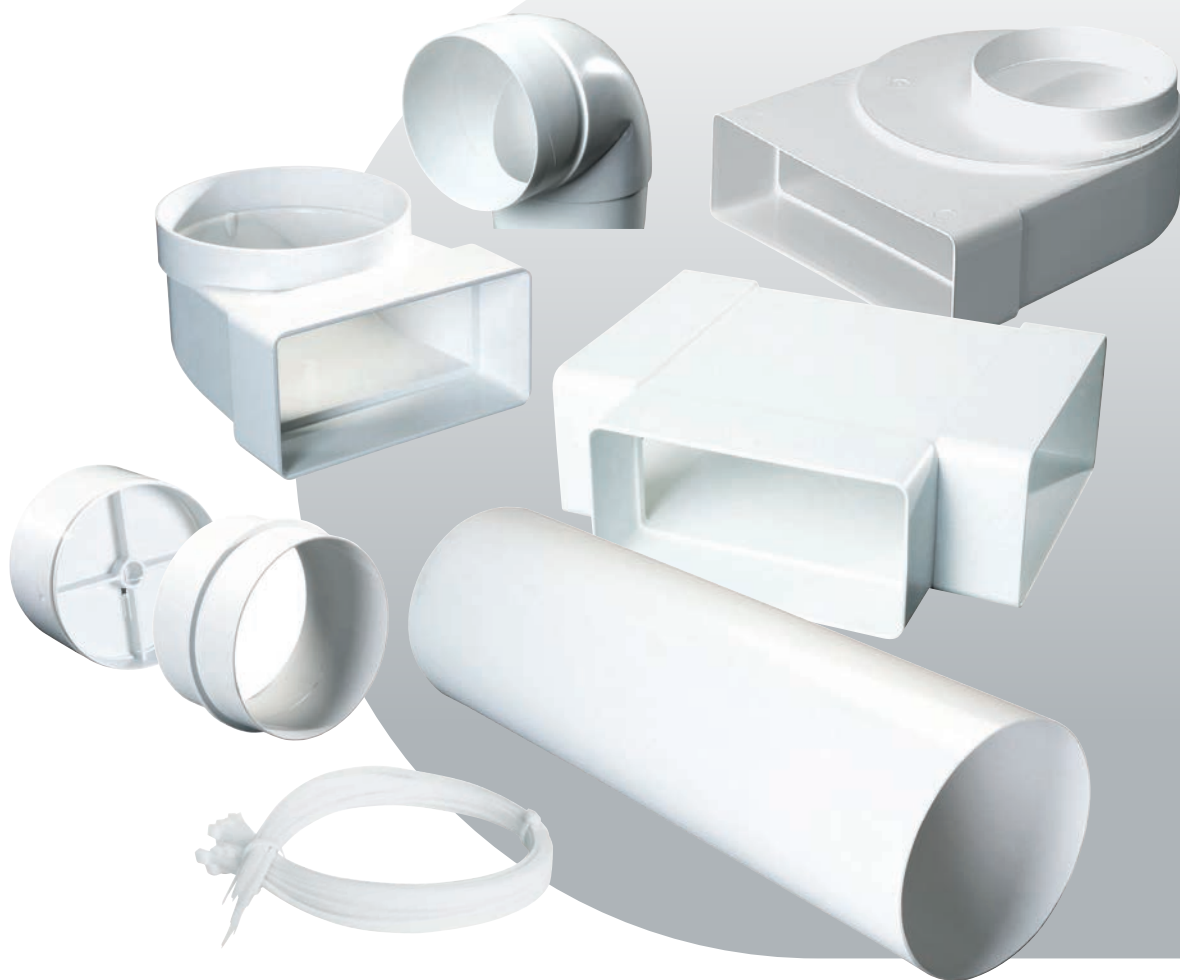

Circular duct

Provides optimum system efficiency. Lightweight with simple push fit connections for ease of installation.

Flat duct systems

Ideal for apartments, ceiling voids, loft and other confined spaces where space is at a premium, without reducing whole system performance. Available in 204mm x 60mm and 220mm x 90mm high performance duct.

Attenuation

Reduce duct noise as per 'Domestic Compliance Guide 2010' and noise requirements in 'Part F Building Regulations 2010'. Attenuator ducting also reduces cross talk through the ventilation systems, between rooms.

Wide selection of internal/external grilles

Designed to maximise system airflow performance and occupant comfort.

Fire protection

Available for all duct systems to meet regulations.

Self Seal

A simple and innovative solution for ducting systems to ensure the air leakage in and out of the duct joint is kept to an absolute minimum.

PVC Flat Ducting

FLAT CHANNEL 1.5m LENGTH									
Part Number	Duct Size	Description	Box Quantity	Resistance in PA					
				@8l/s	@13l/s	@21l/s	@29l/s	@37l/s	
PVC515WH	204mm x 60mm	Flat Channel 1.5m Length	5	0.3	0.6	1.3	2.2	3.3	
PVC4015WH	121mm x 60mm	Flat Channel 1.5m Length	10	0.7	1.5	3.1	5.3	7.9	
PVC015WH	110mm x 54mm	Flat Channel 1.5m Length	10	1.2	2.4	5.3	9	13.7	



FLAT CHANNEL 2m LENGTH									
Part Number	Duct Size	Description	Box Quantity	Resistance in PA					
				@8l/s	@13l/s	@21l/s	@29l/s	@37l/s	
D3-2000	204mm x 60mm	Flat Channel 2m Length	5	0.4	0.8	1.7	2.9	4.4	
D1-2000	121mm x 60mm	Flat Channel 2m Length	10	1.5	3.1	6.7	11.7	17.9	



SLIM DUCT CONNECTORS									
Part Number	Duct Size	Description	Box Quantity	Resistance in PA					
				@8l/s	@13l/s	@21l/s	@29l/s	@37l/s	
PVC520WH	204mm x 60mm	Slim Duct Connector	10	0	0	0	0	0	
PVC420WH	121mm x 60mm	Slim Duct Connector	10	0	0	0	0	0	
PVC020WH	110mm x 54mm	Slim Duct Connector	20	0	0	0	0	0	



CHANNEL CLIPS									
Part Number	Duct Size	Description	Box Quantity	Resistance in PA					
				@8l/s	@13l/s	@21l/s	@29l/s	@37l/s	
PVC122-5WH	204mm x 60mm	Channel Clips	10	0	0	0	0	0	
PVC422WH	121mm x 60mm	Channel Clips	10	0	0	0	0	0	
PVC020WH	110mm x 54mm	Channel Clips	10	0	0	0	0	0	



90° HORIZONTAL BEND									
Part Number	Duct Size	Description	Box Quantity	Resistance in PA					
				@8l/s	@13l/s	@21l/s	@29l/s	@37l/s	
PVC550WH	204mm x 60mm	90° Horizontal Bend	10	0.6	1.82	4.1	7.46	12.8	
PVC450WH	121mm x 60mm	90° Horizontal Bend	10	1.9	4.8	12.3	23.3	37.8	
PVC050WH	110mm x 54mm	90° Horizontal Bend	20	2.6	9.8	19.3	39.8	61	



PVC Flat Ducting

90° VERTICAL BENDS								
Part Number	Duct Size	Description	Box Quantity	Resistance in PA				
				@8l/s	@13l/s	@21l/s	@29l/s	@37l/s
PVC560WH	204mm x 60mm	90° Vertical Bend	10	0.7	1.14	5.0	10.1	16.6
PVC460WH	121mm x 60mm	90° Vertical Bend	10	2.1	5.7	14.8	28.1	45.7
PVC060WH	110mm x 54mm	90° Vertical Bend	20	4.5	15.6	31.8	62.8	95.8



45° HORIZONTAL BEND								
Part Number	Duct Size	Description	Box Quantity	Resistance in PA				
				@8l/s	@13l/s	@21l/s	@29l/s	@37l/s
PVC555WH	204mm x 60mm	45° Horizontal Bend	10	0	0.3	1.2	2.71	4.5

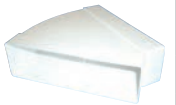

45° VERTICAL BENDS								
Part Number	Duct Size	Description	Box Quantity	Resistance in PA				
				@8l/s	@13l/s	@21l/s	@29l/s	@37l/s
PVC575WH	204mm x 60mm	45° Vertical Bend	10	0	0.3	1.2	2.71	4.6

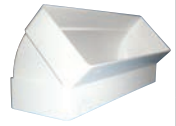

ADAPTORS								
Part Number	Duct Size	Description	Box Quantity	Resistance in PA				
				@8l/s	@13l/s	@21l/s	@29l/s	@37l/s
PVC570WH	204mm x 60mm	125 dia. Round to Rect. Adaptor	10	0	0.96	2.56	3.84	5.12
PVC470WH	121mm x 60mm	100 dia. Round to Rect. Adaptor	10	0.6	1.3	3.1	5.5	8.6
PVC070WH	110mm x 54mm	100 dia. Round to Rect. Adaptor	20	1.1	3.5	7.4	14.6	23.2



FLAT CHANNEL END CAP								
Part Number	Duct Size	Description	Box Quantity	Resistance in PA				
				@8l/s	@13l/s	@21l/s	@29l/s	@37l/s
PVC518WH	204mm x 60mm	Flat Channel End Cap	1	0	0	0	0	0
PVC018WH	110mm x 54mm	Flat Channel End Cap	1	0	0	0	0	0





HORIZONTAL T PIECE								
Part Number	Duct Size	Description	Box Quantity	Resistance in PA				
				@8l/s	@13l/s	@21l/s	@29l/s	@37l/s
PVC582WH	204mm x 60mm	Horizontal T Piece	10	0.9	2.3	5.9	11.2	18.3
PVC018WH	110mm x 54mm	Horizontal T Piece	20	3.5	9.7	25.6	49.2	80.3



PVC Flat Ducting

FAN PLENUM									
Part Number	Duct Size	Description	Box Quantity	Resistance in PA					
				@8l/s	@13l/s	@21l/s	@29l/s	@37l/s	
PVC440WH	204mm x 60mm	Fan Plenum 100mm dia	10	2.1	5.5	14.3	27.2	44.3	
PVC540WH	204mm x 60mm	Fan Plenum 125mm dia	10	0.5	1.3	3.4	6.4	10.4	
PVC641WH	204mm x 60mm	Fan Plenum 150mm dia	6	0.5	1.4	3.6	6.9	11.3	
PVC030WH	110mm x 54mm	Fan Plenum 100mm dia	20	2.1	5.9	15.9	31	51	
PVC430WH	121mm x 60mm	Fan Plenum 100mm dia	10	1.8	4.6	11.7	22.1	35.8	

AIR BRICK ADAPTER									
Part Number	Duct Size	Description	Box Quantity	Resistance in PA					
				@8l/s	@13l/s	@21l/s	@29l/s	@37l/s	
PVC077WH	110mm x 54mm	Airbrick Adaptor	20	0.4	1	2.4	4.4	7	

FLEXIBLE DUCT CONNECTOR									
Part Number	Duct Size	Description	Box Quantity	Resistance in PA					
				@8l/s	@13l/s	@21l/s	@29l/s	@37l/s	
PVC581WH	211mm x 64mm	Flexible Duct Connector	1	0	0	0	0	0	
PVC481WH	121mm x 60mm	Flexible Duct Connector	1	0	0	0	0	0	
PVC381WH	110mm x 54mm	Flexible Duct Connector	1	0	0	0	0	0	

PVC 220 x 90 Ducting & Ancillaries

220 X 90mm DUCTING AND ANCILLARIES						
Part Number	Description	Box Quantity	Resistance in PA			
			@60l/s	@120l/s	@180l/s	
PVC910WH	Flat Channel 1m Length		1	3.3	6.8	
PVC915WH	Flat Channel 1.5m Length		1.5	5	10.4	
D4-2000	Flat Channel 2m Length		2	6.7	13.8	
PVC961WH	Elbow Bend With Rotating Offset Spigot 150mm	6	9	34	75	
PVC957WH	Supertube To MegaDuct Adapter					
PVC977WH	Double Airbrick Adapter					
PVC950WH	Horizontal 90° Bend	6	9	35.7	79.6	
PVC955WH	Horizontal 45° Bend	6	4.6	19.7	46.5	
PVC960WH	Vertical 90° Bend	6	7	28.8	65.9	
PVC975WH	Vertical 45° Bend	6	6	26.8	64.2	
PVC970WH	Round To Rectangular Adapter	6	3.7	14.1	30.7	
PVC922WH	Flat Channel Clip	10				
PVC920WH	Flat Channel Connector	6				
PVC982WH	Horizontal T Piece					

PVC Circular Ducting

RIGID ROUND PIPE 2M									
Part Number	Duct Size	Description	Box Quantity	Resistance in PA					
				@8l/s	@13l/s	@21l/s	@29l/s	@37l/s	
PVC1200-4WH	100mm x 2m	100mm dia Rigid Pipe	3	0.1	0.3	1	1.9	3.1	
PVC1200-5WH	125mm x 2m	125mm dia Rigid Pipe	3	0	0.1	0.4	0.8	1.3	
PVC1200-6WH	150mm x 2m	150mm dia Rigid Pipe	2	0	0	0.2	0.5	0.8	



PIPE CONNECTOR									
Part Number	Duct Size	Description	Box Quantity	Resistance in PA					
				@8l/s	@13l/s	@21l/s	@29l/s	@37l/s	
PVC493WH	100mm	100mm dia Pipe Connector	3	0	0	0	0	0	
PVC593WH	125mm	125mm dia Pipe Connector	3	0	0	0	0	0	
PVC693WH	150mm	150mm dia Pipe Connector	2	0	0	0	0	0	



90° BENDS									
Part Number	Duct Size	Description	Box Quantity	Resistance in PA					
				@8l/s	@13l/s	@21l/s	@29l/s	@37l/s	
PVC490WH	100mm	90° Bend 100mm	10	0.9	2.7	0	0	0	
PVC590WH	125mm	90° Bend 125mm	10	0.5	1.4	4	7.9	13.6	
PVC690WH	150mm	90° Bend 150mm	10	0.5	1.3	3.1	5.9	9.5	



45° BEND									
Part Number	Duct Size	Description	Box Quantity	Resistance in PA					
				@8l/s	@13l/s	@21l/s	@29l/s	@37l/s	
PVC491WH	100mm	45° Bend 100mm	10	0.3	0.9	2.7	5.4	8.9	
PVC591WH	125mm	45° Bend 125mm	10	0.2	0.5	1.4	2.7	4.5	



INLINE BACKDRAUGHT SHUTTER									
Part Number	Duct Size	Description	Box Quantity	Resistance in PA					
				@8l/s	@13l/s	@21l/s	@29l/s	@37l/s	
PVC494WH	100mm	100mm dia Backdraught Shutter	10	12.2	19.6	32	45	58.6	
PVC594WH	125mm	125mm dia Backdraught Shutter	10	9.4	14.8	23.3	31.5	39	
PVC694WH	150mm	150mm dia Backdraught Shutter	10	7.1	11.2	17.4	23.4	29	



PIPE HANGER									
Part Number	Duct Size	Description	Box Quantity	Resistance in PA					
				@8l/s	@13l/s	@21l/s	@29l/s	@37l/s	
PVC496WH	100mm	100mm Pipe Hanger	10	0	0	0	0	0	
PVC596WH	125mm	125mm Pipe Hanger	10	0	0	0	0	0	
PVC696WH	150mm	150mm Pipe Hanger	10	0	0	0	0	0	



PVC Circular Ducting

T PIECE (MALE FITTING)								
Part Number	Duct Size	Description	Box Quantity	Resistance in PA				
				@8l/s	@13l/s	@21l/s	@29l/s	@37l/s
PVC492M	100mm	T Piece 100 x 100 x 100 (Male Fitting)	4	0.7	1.6	4.0	7.4	11.8
PVC592M	125mm	T Piece 125 X 125 X 125 (Male Fitting)	1	0.5	1.0	2.2	3.9	6.1



REDUCING PIECE								
Part Number	Duct Size	Description	Box Quantity	Resistance in PA				
				@8l/s	@13l/s	@21l/s	@29l/s	@37l/s
PVC119WH	125mm ID-100mm OD	Circular Reducing Piece	10	0.6	1.5	3.6	6.6	10.6
PVC121WH	150mm ID-125/100mm OD	Circular Reducing Piece	10	0.4	1.4	4.2	8.4	14

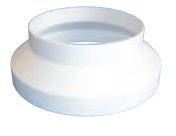

ROUND HOSE CONNECTOR								
Part Number	Duct Size	Description	Box Quantity	Resistance in PA				
				@8l/s	@13l/s	@21l/s	@29l/s	@37l/s
PVC380WH	100mm	Round Hose Connector	10	0	0	0	0	0



T PIECE (FEMALE FITTING)								
Part Number	Duct Size	Description	Box Quantity	Resistance in PA				
				@8l/s	@13l/s	@21l/s	@29l/s	@37l/s
TP 150X150 X100	150mm x 100mm	T Piece 150 x 150 x 100 (Female Fitting)	1	0.1	0.4	1	1.9	3



FLAT CHANNEL WALL PLATE								
Part Number	Duct Size	Description	Box Quantity	Resistance in PA				
				@8l/s	@13l/s	@21l/s	@29l/s	@37l/s
PVC114-4WH	100mm	Wall Plate	10	0	0	0	0	0
PVC114-5WH	125mm	Wall Plate	10	0	0	0	0	0



PVC Flexible Ducting

FLEXIBLE RECTANGULAR DUCTING 3M LENGTH								
Part Number	Duct Size	Description	Box Quantity	Resistance in PA				
				@8l/s	@13l/s	@21l/s	@29l/s	@37l/s
PVC333WH	114mm x 57mm	Rectangular Flexible PVC Duct (3m length)	1	1	2.7	7.2	13.9	22.7
PVC433WH	121mm x 60mm	Rectangular Flexible PVC Duct (3m length)	1	0.4	0.8	1.7	2.8	4.3
PVC533WH	211mm x 64mm	Rectangular Flexible PVC Duct (3m length)	1	0.2	0.6	1.5	2.6	4.1



FLEXIBLE ALUMINIUM DUCTING 5M LENGTH								
Part Number	Duct Size	Description	Box Quantity	Resistance in PA				
				@8l/s	@13l/s	@21l/s	@29l/s	@37l/s
FLD100	5m x 100mm	Aluminium Flexible Duct 100mm	1	0.2	0.6	1.7	3.4	5.6
FLD125	5m x 125mm	Aluminium Flexible 120mm	1	0.4	0.7	1.4	2.5	3.8
FLD150	5m x 150mm	Aluminium Flexible Duct 150mm	1	0.2	0.3	0.6	1	1.5
FLD200	5m x 200mm	Aluminium Flexible Duct 200mm	1	0.2	0.3	0.6	0.9	1.1



FLEXIBLE INSULATED DUCTING 5M LENGTH								
Part Number	Duct Size	Description	Box Quantity	Resistance in PA				
				@8l/s	@13l/s	@21l/s	@29l/s	@37l/s
FLDI100	5m x 100mm	Insulated Flexible Duct 100mm	1	0.2	0.6	1.7	3.4	5.6
FLDI125	5m x 125mm	Insulated Flexible Duct 120mm	1	0.4	0.7	1.4	2.5	3.8
FLDI150	5m x 150mm	Insulated Flexible Duct 150mm	1	0.2	0.3	0.6	1	1.5
FLDI200	5m x 200mm	Insulated Flexible Duct 200mm	1	0.2	0.3	0.6	0.9	1.1



SEMI-RIGID ACOUSTIC DUCTING 3M LENGTH								
Part Number	Duct Size	Description	Box Quantity	Resistance in PA				
				@8l/s	@13l/s	@21l/s	@29l/s	@37l/s
SRDI100	3m x 100mm	Semi-Rigid Acoustic Ducting 100mm	1	0.3	0.6	1.5	2.5	4.4
SRDI125	3m x 125mm	Semi-Rigid Acoustic Ducting 125mm	1	0.1	0.1	0.3	0.7	1.5
SRDI150	3m x 150mm	Semi-Rigid Acoustic Ducting 150mm	1	0	0	0.1	0.3	1.3
SRDI200	3m x 200mm	Semi-Rigid Acoustic Ducting 200mm	1	0	0	0	0	0.2



FLEXIBLE DUCTING 3M LENGTH								
Part Number	Duct Size	Description	Box Quantity	Resistance in PA				
				@8l/s	@13l/s	@21l/s	@29l/s	@37l/s
PVC363WH	3m x 100mm	Flexible Ducting 100mm	1	0.2	0.6	1.7	3.4	5.7



Grilles and Terminals

WHITE STEEL EXTRACT / SUPPLY VALVES								
Part Number	Duct Size	Description	Box Quantity	Resistance in PA				
				@8l/s	@13l/s	@21l/s	@29l/s	@37l/s
V100	100mm dia spigot	100mm dia Extract/Supply Valve (White)	1	7	14	34	85	130
V100S	100mm dia spigot	100 dia Extract/Supply Valve (Stainless Steel)	1	7	14	34	85	130
V125S	125mm dia spigot	125 dia Extract/Supply Valve (White)	1	6	10	19	35	55
V125S	125mm dia spigot	125 dia Extract/Supply Valve (Stainless Steel)	1	6	10	19	35	55



The above resistances are based on 10mm opening setting.

FILTERED INLET GRILLE								
Part Number	Duct Size	Description	Box Quantity	Resistance in PA				
				@8l/s	@13l/s	@21l/s	@29l/s	@37l/s
100IG	100mm x 100mm OD	Filtered Inlet Grilles (White Only)	1	5.8	14.5	37.1	70.2	113.8



LOUVERED GRILLE - WITH FLYSCREEN								
Part Number	Duct Size	Description	Box Quantity	Resistance in PA				
				@8l/s	@13l/s	@21l/s	@29l/s	@37l/s
PVC104WH	100mm dia spigot	Louvered Grille With Flyscreen	20	3.4	7.9	18.9	34.6	54.8
PVC504WH	125mm dia spigot	Louvered Grille With Flyscreen	10	0.8	1.7	3.8	6.6	10.2
PVC604WH	150mm dia spigot	Louvered Grille With Flyscreen	10	0.7	1.3	2.8	4.9	7.4
PVC105WH	110mm dia spigot	Louvered Grille With Flyscreen	20	6.6	15.8	38.4	70.8	112.9



LOW RESISTANCE LOUVERED GRILLE - NO FLYSCREEN								
Part Number	Duct Size	Description	Box Quantity	Resistance in PA				
				@8l/s	@13l/s	@21l/s	@29l/s	@37l/s
PVC104LR	100mm dia spigot	Low Resistance Louvered Grille	20	0.6	1.6	3.9	7.3	11.8



AIR BRICK								
Part Number	Duct Size	Description	Box Quantity	Resistance in PA				
				@8l/s	@13l/s	@21l/s	@29l/s	@37l/s
PVC501WH	201mm x 57mm	Air Brick With Shutter	20	6.4	10.1	17.3	26.1	36.5
PVC505NS	201mm x 57mm	Air Brick - No Shutter	20	2.2	5.5	13.9	26.0	41.8

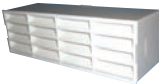



Nuaire external grilles supplied white (RAL 9010) as standard.
For alternative colours please replace the **WH** at the end of the product code with:

BR for Brown (RAL 8017) ● **COT** for Beige-Cotswold (RAL 1001) ● **TC** for Red-Terracotta (RAL 8012) ●

Grilles and Terminals

DOUBLE AIR BRICK									
Part Number	Duct Size	Description	Box Quantity	Resistance in PA					
				@8l/s	@13l/s	@21l/s	@29l/s	@37l/s	
PVC905WH	204mm x 60mm	Double Air Brick	10	0.4	0.9	2.1	3.8	5.9	

UNIVERSAL COWL - SLATE GREY									
Part Number	Duct Size	Description	Box Quantity	Resistance in PA					
				@8l/s	@13l/s	@21l/s	@29l/s	@37l/s	
PVC4411	100mm - 150mm dia spigot	Universal 100mm x 150mm Cowl	1	0.5	0.9	1.7	2.6	3.7	

GRAVITY SHUTTER WALL OUTLET									
Part Number	Duct Size	Description	Box Quantity	Resistance in PA					
				@8l/s	@13l/s	@21l/s	@29l/s	@37l/s	
PVC100WH	100mm dia spigot	Wall Outlet With Gravity Flaps	20	4.8	6.9	9.8	11.7	12.8	
PVC101WH	110mm x 54mm	Wall Outlet With Gravity Flaps	20	6.2	8.6	11.6	13.6	14.6	
PVC506WH	125mm dia spigot	Wall Outlet With Gravity Flaps	10	3.6	5.5	8.1	10.1	11.5	

COWLED WALL OUTLET WITH DAMPER									
Part Number	Duct Size	Description	Box Quantity	Resistance in PA					
				@8l/s	@13l/s	@21l/s	@29l/s	@37l/s	
PVC102WH	100mm dia spigot	Cowled Wall Outlet With Damper	20	2.6	4.4	8.1	12.9	18.8	
PVC103WH	110mm x 54mm	Cowled Wall Outlet With Damper	20	1.8	3.8	9	16.5	26.4	
PVC502WH	125mm dia spigot	Cowled Wall Outlet With Damper	10	3.6	5.5	8.0	10.1	11.6	

ROOF COWL									
Part Number	Duct Size	Description	Box Quantity	Resistance in PA					
				@8l/s	@13l/s	@21l/s	@29l/s	@37l/s	
4RC	100mm dia spigot	Roof Cowl 100mm	1	2.3	6	15.7	29.9	48.7	

WALL COWL									
Part Number	Duct Size	Description	Box Quantity	Resistance in PA					
				@8l/s	@13l/s	@21l/s	@29l/s	@37l/s	
4WC	100mm dia spigot	Wall Cowl 100mm	1	2.2	6.2	16.4	31.6	51.5	

Nuair external grilles supplied white (RAL 9010) as standard.
For alternative colours please replace the **WH** at the end of the product code with:

BR for Brown (RAL 8017) ● **COT** for Beige-Cotswold (RAL 1001) ● **TC** for Red-Terracotta (RAL 8012) ●

Grilles and Terminals

WALL MOUNTING SHUTTERS								
Part Number	Duct Size	Description	Box Quantity	Resistance in PA				
				@8l/s	@13l/s	@21l/s	@29l/s	@37l/s
PVCWALL/1	100mm dia spigot	Wall Mounting Gravity Operated Anti-Backdraught Shutters and Wall Duct	1	3.4	5.3	8.1	10.9	13.6



WALL MOUNTING LOUVRE								
Part Number	Duct Size	Description	Box Quantity	Resistance in PA				
				@8l/s	@13l/s	@21l/s	@29l/s	@37l/s
PVCWALL/2	100mm dia spigot	Wall Mounting Weather Louvre With Fly Screen and Telescopic Wall Duct	1	3.7	9.6	24.9	47.4	77



WALL MOUNTING RECTANGULAR COWLED OUTLET								
Part Number	Duct Size	Description	Box Quantity	Resistance in PA				
				@8l/s	@13l/s	@21l/s	@29l/s	@37l/s
PVCWALL/3	100mm dia spigot	Wall Mounting Rectangular Cowled Outlet Complete With Anti-Backdraught Damper and Telescopic Wall Duct 300mm - 550mm	1	3.5	7.3	15.8	27.2	41.7



WALL MOUNTING CIRCULAR COWLED OUTLET								
Part Number	Duct Size	Description	Box Quantity	Resistance in PA				
				@8l/s	@13l/s	@21l/s	@29l/s	@37l/s
PVCWALL/4	100mm dia spigot	Wall Mounting Circular Cowled Outlet With Telescopic Wall Duct 300mm x 550mm	1	2.3	6	15.4	29.2	47.2



WALL MOUNTING AIRBRICK								
Part Number	Duct Size	Description	Box Quantity	Resistance in PA				
				@8l/s	@13l/s	@21l/s	@29l/s	@37l/s
PVCWALL/5	100mm dia spigot	Wall Mounting Air Brick With Reducer 155mm Length of 110mm x 54mm Duct And Rectangular to 100mm dia Adaptor	1	10.9	17.7	30.5	45.6	62.9



WALL MOUNTING WEATHER LOUVRE								
Part Number	Duct Size	Description	Box Quantity	Resistance in PA				
				@8l/s	@13l/s	@21l/s	@29l/s	@37l/s
PVCWALL/6	100mm dia spigot	Low Resistance Wall Mounting Weather Louvre And Telescopic Wall Duct 300mm x 550mm	1	0.6	1.6	3.9	7.3	12



HIGH RISE								
Part Number	Duct Size	Description	Box Quantity	Resistance in PA				
				@8l/s	@13l/s	@21l/s	@29l/s	@37l/s
PVC2447T	100mm dia spigot	High Rise 100mm Round Cowl	1	6.5	17.2	44.9	85.7	139.5





Nuaire external grilles supplied white (RAL 9010) as standard.
For alternative colours please replace the **WH** at the end of the product code with:

BR for Brown (RAL 8017) ● **COT** for Beige-Cotswold (RAL 1001) ● **TC** for Red-Terracotta (RAL 8012) ●

Attenuators & Additional Ancillaries

SLIMDUCT SILENCER									
Part Number	Duct Size	Description	Box Quantity	Resistance in PA					
				@8l/s	@13l/s	@21l/s	@29l/s	@37l/s	
MEV-SIL10	204mm x 60mm	Slimduct Silencer 1000mm	1	5.2	10	13.5	17	64.7	
MEV-SIL15	204mm x 60mm	Slimduct Silencer 1500mm	1	3.4	7.8	13.5	23.5	64.7	

CONDENSATION TRAP									
Part Number	Duct Size	Description	Box Quantity	Resistance in PA					
				@8l/s	@13l/s	@21l/s	@29l/s	@37l/s	
CONTRAP100	100mm	Condensation Trap 100mm dia	1	0.3	1	3	6.1	10.3	
CONTRAP125	125mm	Condensation Trap 125mm dia	1	0.3	1	3	6.1	10.3	
CONTRAP150	150mm	Condensation Trap 150mm dia	1	0.3	1	3	6.1	10.3	

INLINE CONDENSATION DRAIN									
Part Number	Duct Size	Description	Box Quantity	Resistance in PA					
				@8l/s	@13l/s	@21l/s	@29l/s	@37l/s	
MVHR-DRAIN	22mm	Inline Condensate Drain	1	0	0	0	0	0	

DYNO TIES									
Part Number	Duct Size	Description	Box Quantity	Resistance in PA					
				@8l/s	@13l/s	@21l/s	@29l/s	@37l/s	
DT33	150mm - 200mm OD	Dyno Ties Up To 200mm dia	1	0	0	0	0	0	

DUCT ACCESSORIES									
Part Number	Duct Size	Description	Box Quantity	Resistance in PA					
				@8l/s	@13l/s	@21l/s	@29l/s	@37l/s	
PVCDSEAL	N/A	Duct Sealant	1	0	0	0	0	0	
PVC50TP45	N/A	Aluminium Duct Tape 45m	1	0	0	0	0	0	
PVCFSEAL	N/A	Intumescent Duct Sealant	1	0	0	0	0	0	

Attenuators & Additional Ancillaries





CIRCULAR FIRE DAMPER								
Part Number	Duct Size	Description	Box Quantity	Resistance in PA				
				@8l/s	@13l/s	@21l/s	@29l/s	@37l/s
CFD-100-E60S	100mm	Circular Fire Damper 100mm	1	5.6	8.7	15.6	24.8	36.2
CFD-125-E60S	125mm	Circular Fire Damper 125mm	1	0	0.5	2.6	5.8	10.8
CFD-160-E60S	160mm	Circular Fire Damper 106mm	1	-	-	-	-	-
CFD-200-E60S	200mm	Circular Fire Damper 200mm	1	-	-	-	-	-



CIRCULAR FIRE DAMPER AIR VALVE								
Part Number	Duct Size	Description	Box Quantity	Resistance in PA				
				@8l/s	@13l/s	@21l/s	@29l/s	@37l/s
V-FD100-E60S	100mm	Circular Fire Damper Air Valve 100mm	1	1	5.7	24.6	53.6	92.7
V-FD125-E60S	125mm	Circular Fire Damper Air Valve 125mm	1	0	2.6	11.3	24.7	42.8



FIRE WRAP								
Part Number	Duct Size	Description	Box Quantity	Resistance in PA				
				@8l/s	@13l/s	@21l/s	@29l/s	@37l/s
PVC087-110X50	110mm x 54mm	Fire Brake Duct Connector	1	0	0	0	0	0
PVC587-204X60	204mm x 60mm	Fire Brake Duct Connector	1	0	0	0	0	0
PVC588	125mm	Intumescent Fire Brake	1	0	0	0	0	0
FW110X54	110mm x 54mm	Fire Wrap	1	0	0	0	0	0
FW204X60	204mm x 60mm	Fire Wrap	1	0	0	0	0	0
FWS110X54	110mm x 54mm	Fire Collar	1	0	0	0	0	0
FWS204x60	204mm x 60mm	Fire Collar	1	0	0	0	0	0

Wrap

Collar

Ductmaster Radial NRD75

Nuaire Ductmaster radial ducting (NRD75) is a range of ducting and ancillaries intended for installation in domestic properties.

Nuaire's Ductmaster Radial is a range of semi-rigid ducting and ancillaries. Unlike other types of ducting, Ductmaster Radial negates the need for multiple lengths of duct, bends and ancillaries, minimising duct leakage and reducing installation time.

Unlike other types of ducting systems Nuaire's radial ducting design negates the need for multiple lengths of duct, bends and ancillaries minimising duct leakage and reducing installation time.

Nuaire's radial ducting system is designed to use with Nuaire Thermal Ducting and allows quick and easy installation without the need for any tapes or sealants.

Using Nuaire radial ducting will achieve a level of leakage substantially lower than the maximum allowed for a class A duct as defined in DW/143 (Ductwork leakage testing). Nuaire radial ducting is fully Sap Appendix Q accredited for use in new build properties.



Typical Installation

INSTALLATION OPTIONS

This is an example of a variant where the Manifolds (air distribution boxes) have been mounted above a lowered ceiling. The lowered ceilings will have to be constructed in such a way that the air distribution boxes remain accessible. A centralised Heat Recovery unit distributes and extracts the air to and from the dwelling through the Manifold outlets and Ductmaster radial duct. Ductmaster Thermal Duct is used in the cold space.

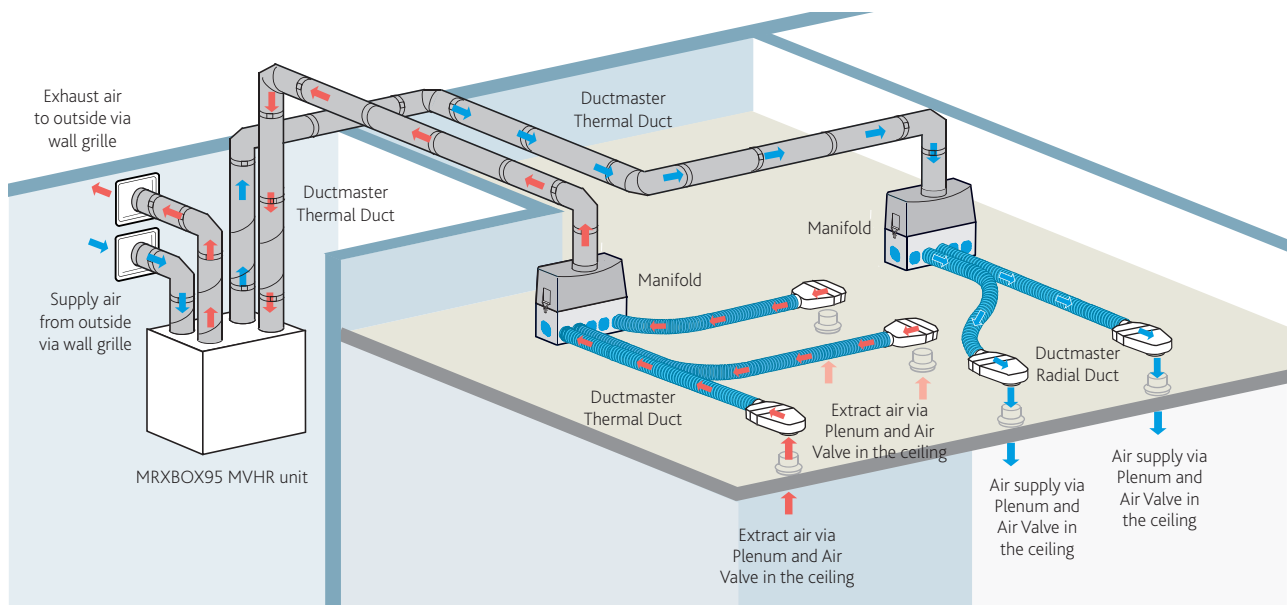



Ductmaster Radial

40M OF BLUE RADIAL DUCT			
Part Number	Duct Size	Description	
NRD75-B40M	40m Length x 75mm dia	Blue Radial Duct	

40M OF RED RADIAL DUCT			
Part Number	Duct Size	Description	
NRD75-R40M	40m Length x 75mm dia	Red Radial Duct	

8 PORT MANIFOLD BOX			
Part Number	Duct Size	Description	
NRD75-MANCOM-150	75mm	Manifold Box With 8 Ports	

12 PORT MANIFOLD BOX			
Part Number	Duct Size	Description	
NRD75-MAN-150	75mm	12 Port Insulated Manifold	

8 PORT MANIFOLD BOX			
Part Number	Duct Size	Description	
NRD75-MAN-125	75mm	8 Port Insulated Manifold	

WALL PLENUM WITH GRILLE			
Part Number	Duct Size	Description	
NRD75-WG	75mm	Wall Plenum With Grille	

FLOOR PLENUM WITH GRILLE			
Part Number	Duct Size	Description	
NRD75-FG	75mm	Floor Plenum With Grille	

RESTRICTION RING			
Part Number	Duct Size	Description	
NRD75-RING	75mm	Restriction Ring	

Ductmaster Radial

DUST CAP		
Part Number	Duct Size	Description
NRD75-DUCT-CAP	75mm	Dust Cap (Red)for Ducting



MANIFOLD TO DUCT CONNECTOR		
Part Number	Duct Size	Description
NRD75-MAN-CON	75mm	Manifold to Duct Connector



90° MANIFOLD TO DUCT CONNECTOR		
Part Number	Duct Size	Description
NRD75-MAN-90-CON	75mm	90° Manifold to Duct Connector



DUCT CONNECTOR		
Part Number	Duct Size	Description
NRD75-DUCT-CON	75mm	Duct Connector



90° BEND DUCT CONNECTOR		
Part Number	Duct Size	Description
NRD75-DUCT-90	75mm	90° Bend Duct Connector



90° BEND WITH FIXING PLATE		
Part Number	Duct Size	Description
NRD75-DUCT-90FP	75mm	90° Bend With Fixing Plate



2 PORT CEILING VALVE PLENUM CONNECTOR		
Part Number	Duct Size	Description
NRD75-VPL	75mm	2 Port Ceiling Valve Plenum Connector



2 PORT WALL VALVE PLENUM CONNECTOR		
Part Number	Duct Size	Description
NRD75-HPL	75mm	2 Port Wall Valve Plenum Connector

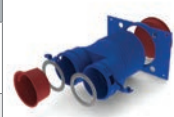

DUST CAP FOR CONNECTORS		
Part Number	Duct Size	Description
NRD75-CON-CAP	75mm	Dust Caps (Red) for Connectors



MOUNTING BRACKET		
Part Number	Duct Size	Description
NRD75-MB	75mm	Mounting Bracket



CEILING VALVE		
Part Number	Duct Size	Description
NRD75-VALVE	75mm	Ceiling Valve



DUCT CONNECTOR		
Part Number	Duct Size	Description
NRD75-SEAL	75mm	Sealing Rings



Acoustic Ventilator

Nuaire Acoustically treated ventilator minimises noise pollution when background ventilation is required.

The provision of fresh air for rapid ventilation to all apartments is to be available without any inconvenience that may be caused by noise pollution from the road immediately adjacent to the development. To this end any apartments situated on the main road are to be provided with an acoustically treated ventilator. These are to be situated in the external wall of any room overlooking the road.

N.B. ALL rooms in corner/end apartments where one or more rooms overlook the road are to have the acoustic ventilators provided, regardless of that particular room's proximity to the road.

Features

- Manual operation for total flexibility
- Airflow 38l/s @ 50Pa when fully open
- Prevents ingress of wind, rain etc with externally fitted baffle
- Aluzinc finish can be painted to allow blending into any environment
- Telescopic design allows for differing wall thicknesses
- Class 0 rated flame retardant acoustic material
- SRL test report available
- 3 year warranty

The acoustic ventilator shall be a manually operated device used at the discretion of the apartment's occupier and when in use shall allow fresh air to pass into the room in question. The fresh air flow will be a combination of natural infiltration and fan assisted via the apartment's ventilation system. The unit's air flow characteristic shall be 38l/s @50Pa when the adjustable regulating plate is fully open. When the acoustic ventilator is in use any externally generated noise from the adjacent road shall be kept to acceptable levels and shall be equivalent to that of the particular unit specified elsewhere in this document.

The acoustic ventilator shall have a baffle plate mounted externally and an adjustable regulating plate on the internal face both suitable for paint finishing. The external baffle shall act as a weather shield stopping the ingress of wind, rain, etc. and shall be manufactured from aluminium alloy. The adjustable regulating plate shall be of a blank appearance so as to appear neutral to the wall in which it is situated. The adjustable regulating plate will be hinged for operation; the hinge mechanism will be graduated to facilitate the adjustment.



The unit casing shall be manufactured from Aluzinc corrosion protected steel and shall be of a minimum 1.5mm thickness.

The unit dimensions shall be 450mm wide x 200mm high x 200mm deep (min), the depth of the unit shall be telescopic to suit different wall thicknesses; this facility shall not affect the acoustic properties or the air flow characteristics of the acoustic ventilator.

The acoustic media used within the unit shall be flame retardant material, Class 0 rated. Unit shall be all as per model reference ACC-400 as manufactured by Nuaire Ltd.

The unit shall have a 3 year warranty.

Acoustic performance

(Summary – for full data see SRL test report C/04/5L/3108/1 method BS EN ISO 717-1:1997).

Vent in closed position:-	Rw (C;Ctr)	54
Vent in open position:-	Rw (C;Ctr)	46
For comparison, 220mm cavity wall without penetration:-		
	Rw (C;Ctr)	58

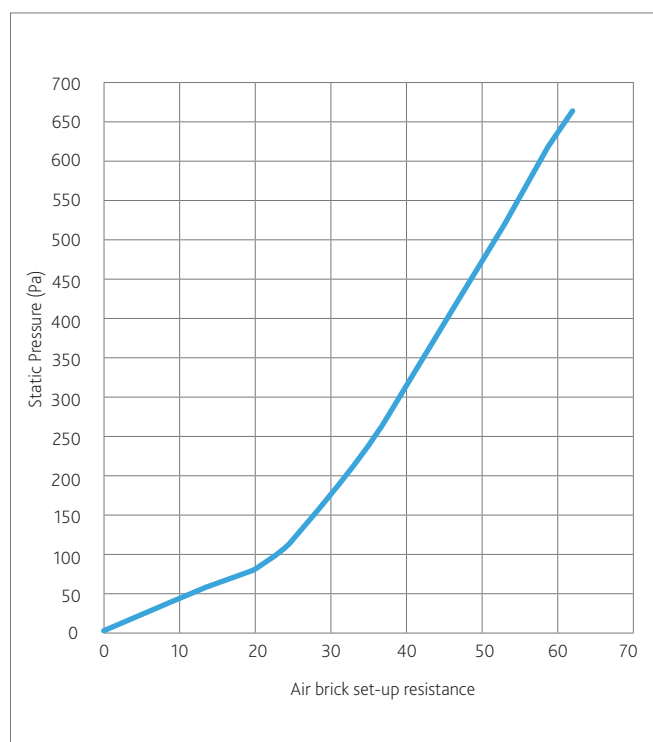

Inline Attenuation

Available in 0.5m, 1m & 1.5m lengths

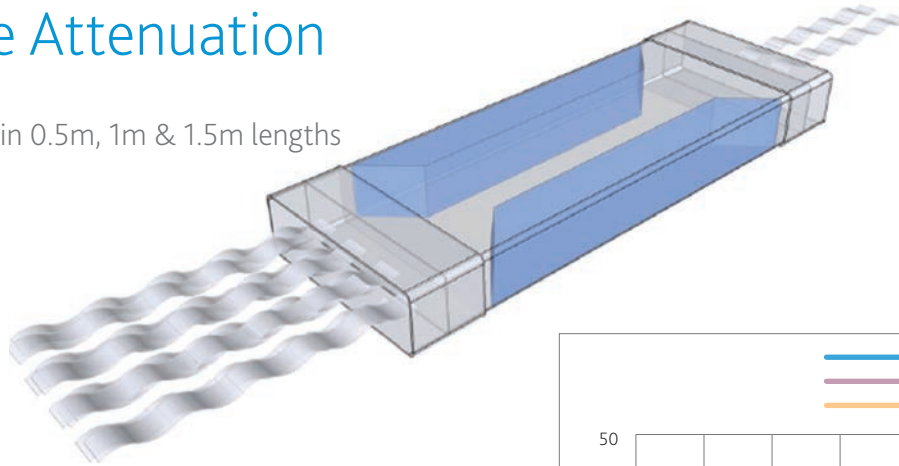

Features

- Regulation driven to reduce duct noise for designers “Domestic Compliance Guide 2010” & noise requirements Part F 2010
- Corrosion Proof - Lightweight PVC removes the risk of corrosion
- Reduce cross talk room to room noise
- Prevents noise ingress for inner city development
- Space Saving - Slim line low profile design for integration within your ducting system

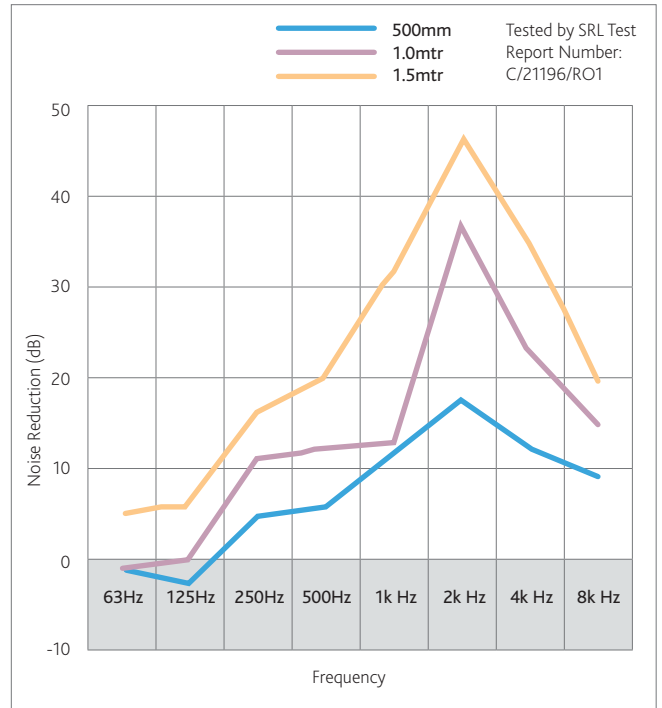

PRODUCT RANGE

Silencer Code	Description	Width	Length	Height
PVCSIL-500	System 204 Duct Silencer x 500mm	204mm	580mm	65mm
PVCSIL-1000	System 204 Duct Silencer x 1.0mtr	204mm	1080mm	65mm
PVCSIL-1500	System 204 Duct Silencer x 1.5mtr	204mm	1580mm	65mm

THE LEVEL OF SOUND ABSORPTION

Silencer Length	125Hz	250Hz	500Hz	1kHz	2kHz	4kHz	8kHz
500mm	-3	5	6	12	18	12	9
1.0mtr	0	11	12	13	37	23	15
1.5mtr	6	16	20	32	47	35	20

STATIC PRESSURE DROP IN PASCALS (PA) VERSUS FLOW RATE (L/S)

Approximate l/s		15	30	60	90	120	150
PVCSIL-500	pa	10.5	18.5	100	213	371	576
PVCSIL-1000	pa	10.4	17.2	107	234	373	578
PVCSIL-1500	pa	8.2	23.5	107	230	412	595

TIME-SAVING DUCTMASTER THERMAL HELPS BULLOCK CONSTRUCTION DELIVER LOW-ENERGY HOMES ON SCHEDULE

The Project

Forward-thinking Social Housing provider, the Accord Group, is bringing low-energy, affordable housing to families in the Charlemont region of West Bromwich. Work began in September 2013 to build the £4m development of eco-friendly houses and flats; designed by Accord InDesign and built by Bullock Construction, with energy-efficient ventilation supplied by Nuaire.



Miles, an MVHR installer for Bullock Construction, explained: "Normal ducting takes us two to three days to install, but with Nuaire Ductmaster Thermal, it takes half a day to a day, maximum. For me, the best feature is how lightweight it is, it's much easier going up into the loft and moving around when you are on a step ladder."



FOLLOW THE QR CODE TO WATCH THE DUCTMASTER THERMAL RACE

Sean Flaherty, Project Manager for Bullock Construction, cited the ease of installation as the products USP: "The Nuaire Ductmaster Thermal range is more user-friendly for the operatives to install. It's lighter; the clips come with the ducting and are easy to fix and the ducting is much easier to use. The old method was time-consuming and much heavier for the installers. Now they can use a step ladder for access, which is much easier."



A previously run-down ex-council site that had remained untouched for over a decade, the re-development of the suburban site at Beaconview Road will bring affordable rental and shared-ownership accommodation to local families on housing waiting lists.

Comprising 12 two-bedroom flats and 28 two, three and four bedroom houses, the timber-framed properties will offer comfortable, modern and, crucially, low-carbon living for the new tenants and owners.



The Challenge

When installing MVHR systems, much time is spent on the labour-intensive practice of insulating PVC pipes, with many of the processes used not conforming with building regulations. Ductmaster Thermal is an all-in-one system where the material used for the insulation is the duct itself. It is the only all-in-one solution that is fully compliant with building regulations. It features a unique clamping mechanism which forms an air-tight seal, eliminating the risk of condensation forming in the duct. With no need for sealant or tape, installation is simple and quick, lowering both costs and time spent on site.

The latest building services products and methods have been utilised to create a warm and healthy indoor environment, including Nuaire's high performance MVHR systems and award winning thermal ducting range: Ductmaster Thermal™. This innovative product range was developed to help housebuilders meet building regulations and save time and money on site. Ductmaster Thermal solves the issue of insulating ducting through unheated spaces; an area highlighted by the NHBC guidance document.

The eco-friendly housing development is now complete, with occupants starting to benefit from lower energy bills and excellent indoor air quality. By using Ductmaster Thermal on the project, not only have Bullock Construction been able to complete the development on schedule, but they have ensured that the MVHR installations comply with current building regulations and NHBC guidance, achieving the system performance specified at the ventilation design stage.

housebuilder
product
awards
2014
winner



NO MORE SEALANT & TAPE



NOW AVAILABLE IN
220mm x 90mm



Nuaire Self-Seal

Nuaire Self-Seal is a simple and innovative solution for ducting systems to ensure the air leakage in and out of the duct joint is kept to an absolute minimum. This unique design removes the requirement for traditional taping and sealing of ducted joints and significantly reduces onsite installation time. The component provides a fit and forget solution and offers optimum performance compared to standard ducting fittings.

- Meets all building requirements
- Guarantees the correct airflow every time
- Simple push-fit connection
- Prevents the ingress of dust and debris into the ducting systems
- Available in 125mm round pipe fitting and 204mm rectangular pipe fitting

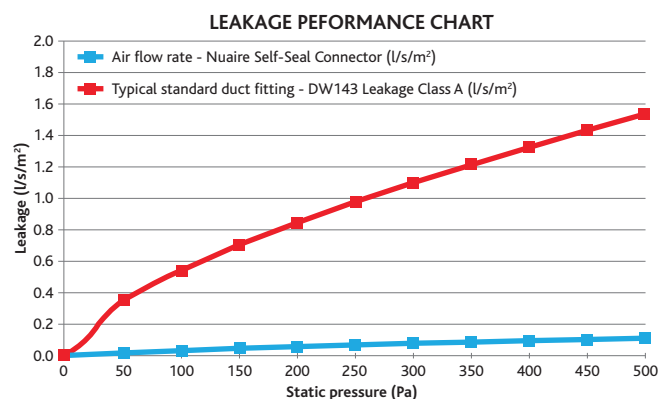

For more details call **029 2085 8500**
email enquiries@nuaire.co.uk
or visit www.nuaire.co.uk/residential



NUAIRE LIMITED

Western Industrial Estate
Caerphilly
CF83 1NA

Residential product orders or enquiry:

Tel: +44 (0)29 2085 8500
Fax: +44 (0)29 2085 8555
info@nuaire.co.uk

After sales technical support:

Tel: +44(0)29 2085 8400
Fax: +44(0)29 2085 8555
info@nuaire.co.uk

www.nuaire.co.uk

 @nuaireHomes

As part of our policy of continuous product development Nuairé reserves the right to alter specifications without prior notice. Telephone calls may be recorded for quality and training purposes.